

Audio distribution in pilot's right side armrest.

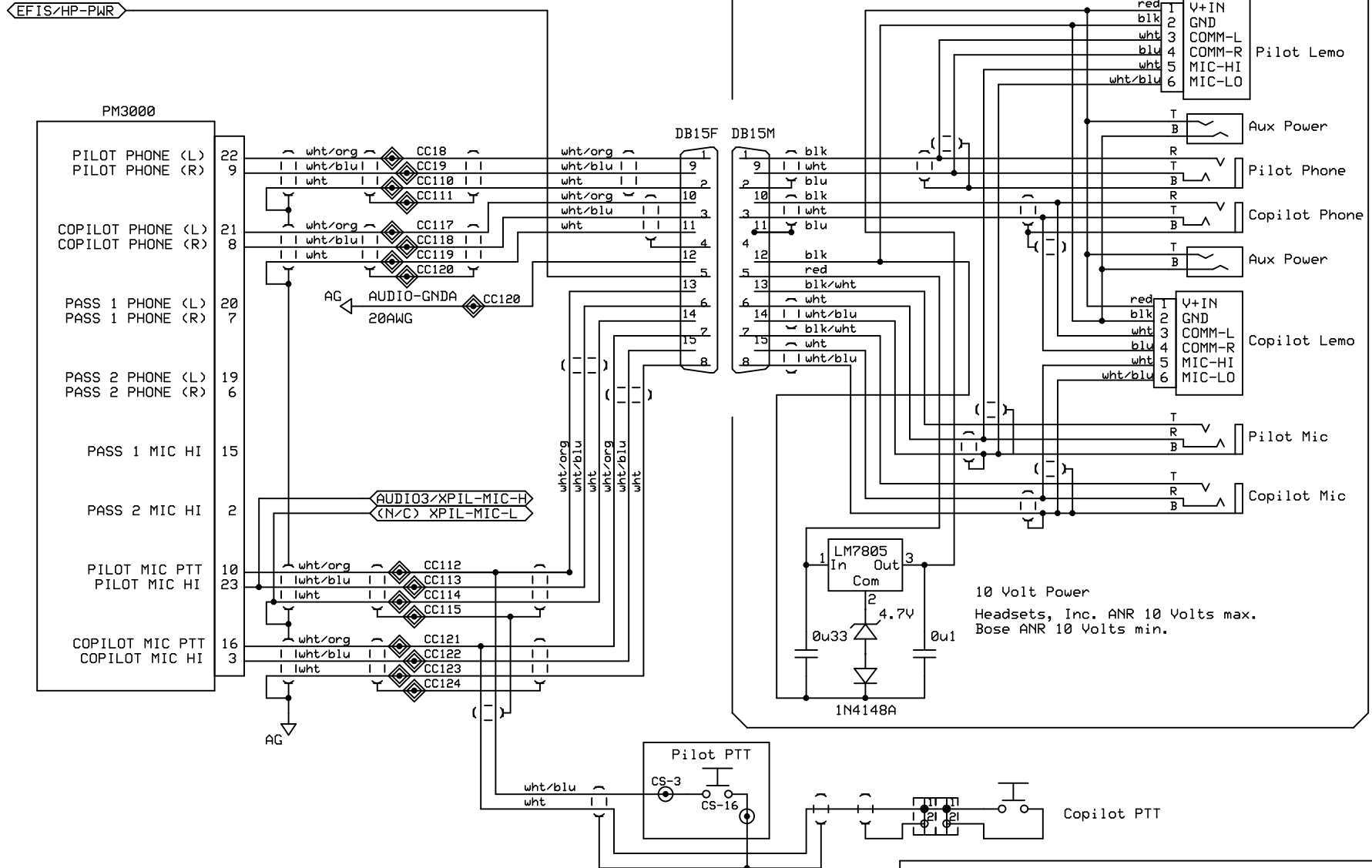

- ◊ Denotes CPC panel connector
 - Indicates pilot control stick connector
- Aux Power and Lemo connectors are provided 10 volts from regulator circuit.

RV-4/HR-II 4325-251		
Electrical System		
V. R. Little	(c) 2015 Vx Aviation	AUDI02